

THE MEADOWS

EVENTS & CONFERENCE CENTER

Click your room

[Index](#)

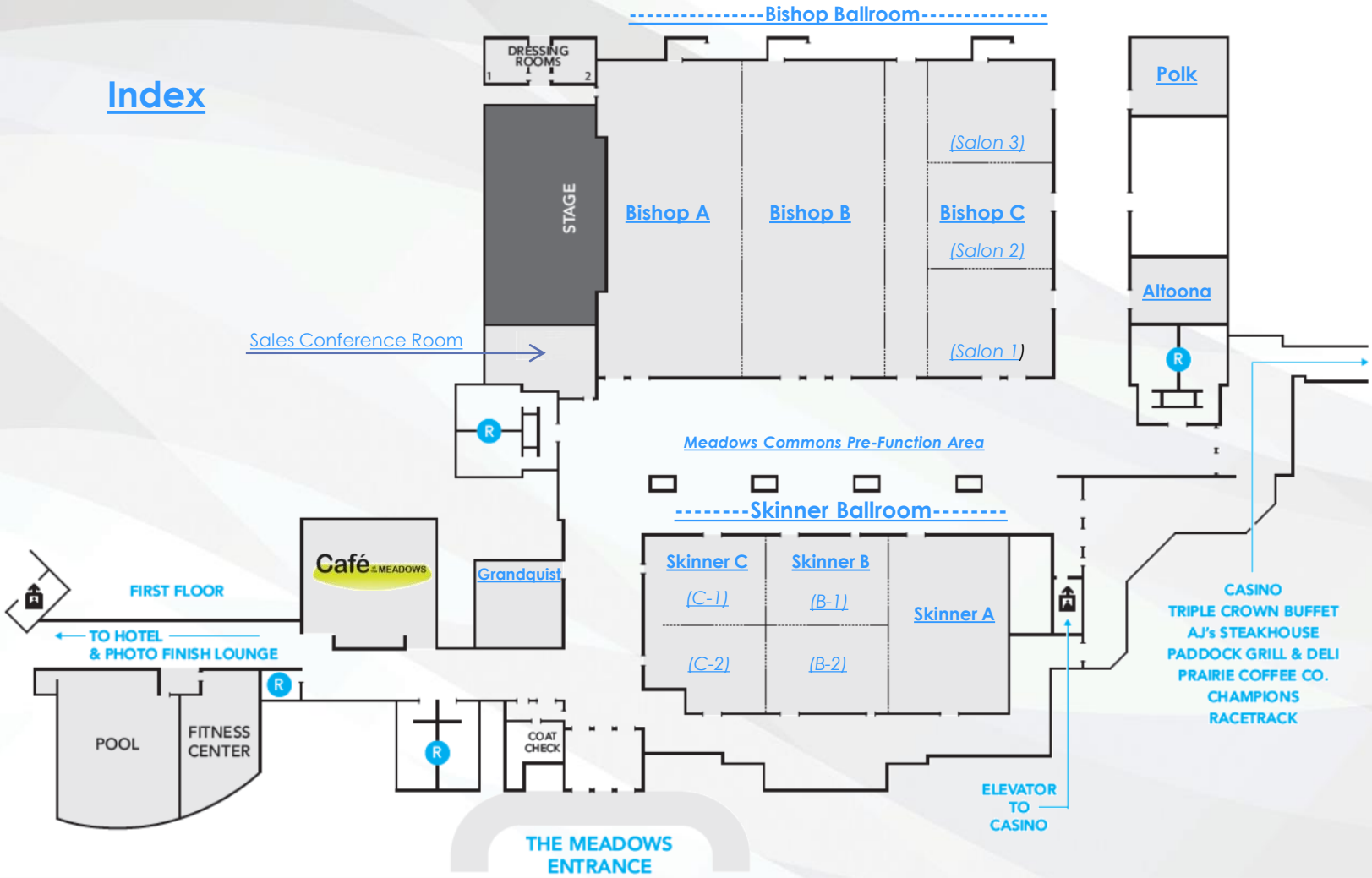

THE MEADOWS

EVENTS & CONFERENCE CENTER

Event Center Map

Room Name	Square Feet	Dimensions	Ceiling Height	Banquet-Per table 6/8/10	Theater	Classroom Type of table 8/6'	U-Shape	Exhibits 10X10/10X8
Bishop Ballroom	14,157	143' x 99'	25'	576/768/960	1440	486/456	N/A	66/82
Bishop Ballroom A	4,455	45' x 99'	25'	144/192/240	360	108/120	N/A	19
Bishop Ballroom B	4,455	45' x 99'	25'	192/256/320	360	132/144	N/A	19
Bishop Ballroom C	3,861	39' x 98'	25'	144/192/240	320	132/104	N/A	17
Salon 1	1,326	39' x 34'	25'	54/72/90	112	36/40	36	6
Salon 2	1,287	39' x 33'	25'	54/72/90	112	36/40	36	6
Salon 3	1,248	39' x 31'	25'	54/72/90	120	36/40	36	6
Skinner Ballroom	6,270	114' x 55'	13'	234/312/390	504	156/180	72	30/30
Skinner Ballroom A	2,090	38' x 55'	13'	72/96/120	192	72/60	33	10/10
Skinner Ballroom B	2,090	38' x 55'	13'	72/96/120	198	72/70	42	10/10
Skinner B1	1,026	38' x 27'	13'	36/48/60	100	36/40	21	N/A
Skinner B2	1,026	38' x 27'	13'	36/48/60	100	36/40	21	N/A
Skinner Ballroom C	1,824	38' x 48'	13'	66/88/110	189	45/52	33	9
Skinner C1	1,026	38' x 27'	13'	30/40/50	94	33/38	21	N/A
Skinner C2	760	38' x 20'	13'	30/40/50	70	27/28	18	N/A
Meadows Commons Pre-Function Area	8,240	206' x 40'	25' / 11'	N/A	N/A	N/A	N/A	22/22
Altoona Room	630	30' x 21'	9'	24/32/40	60	18/24	18	N/A
Polk County Room	720	30' x 24'	9'	24/32/40	72	18/30	18	N/A
Grandquist Conference Room	780	26' x 30'	10'	24/32/40	60	24	18	N/A
Prairie Rose Room	1,058	23' x 46'	9'	64	N/A	24	36	N/A
Pavilion	2,967	35' x 86'	13'	140	300	100	85	13

THE MEADOWS

EVENTS & CONFERENCE CENTER

Index Event Center Map

Room Name	Square Feet	Dimensions	Ceiling Height	Banquet-Per table 6/8/10	Theater	Classroom Type of table 8'/6'	U-Shape	Exhibits 10X10/10X8
Bishop Ballroom	14,157	143' x 99'	25'	576/768/960	1440	486/456	N/A	66/82

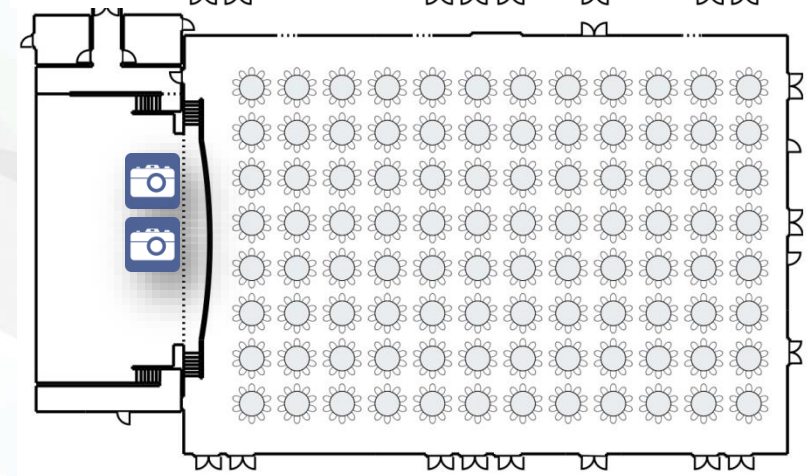
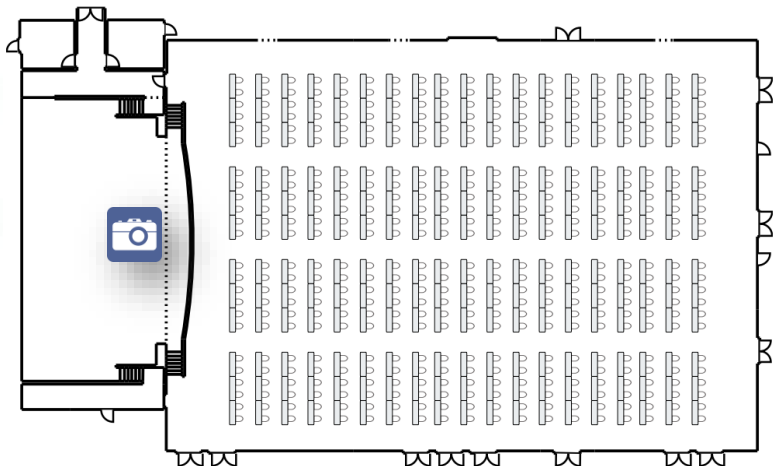
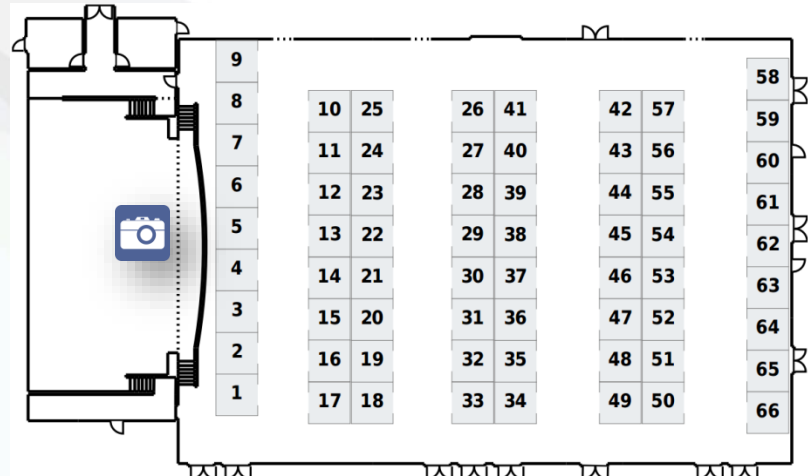
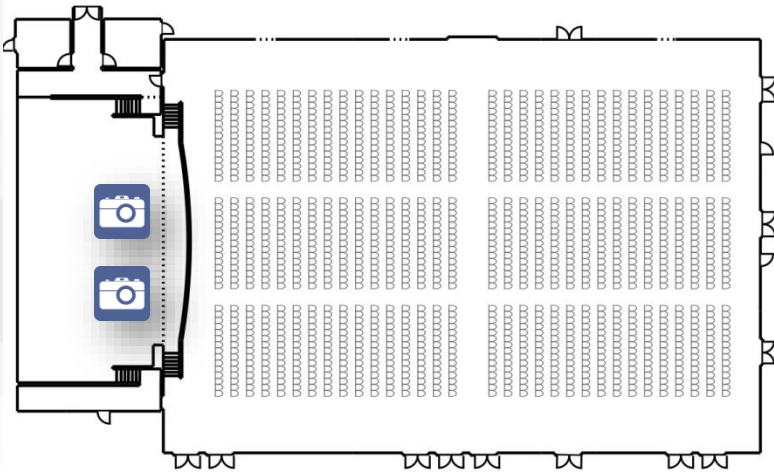

THE MEADOWS

EVENTS & CONFERENCE CENTER

[Index](#)
[Event Center Map](#)

Room Name	Square Feet	Dimensions	Ceiling Height	Banquet-Per table 6/8/10	Theater	Classroom Type of table 8/6'	U-Shape	Exhibits 10X10/10X8
Bishop Ballroom A	4,455	45' x 99'	25'	144/192/240	360	108/120	N/A	18

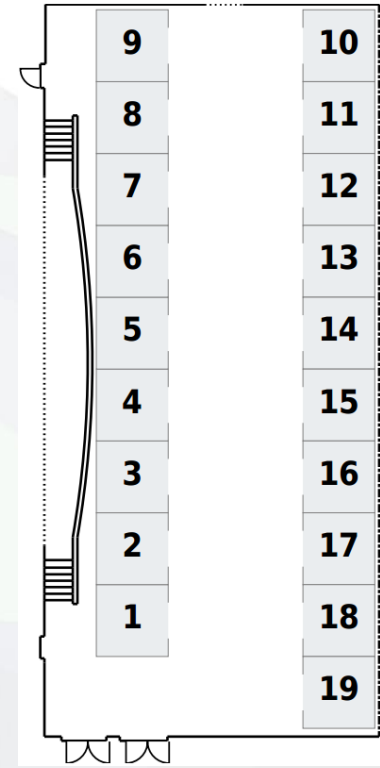
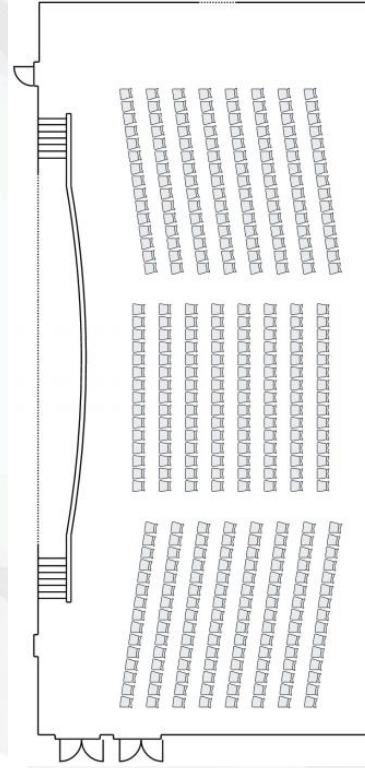
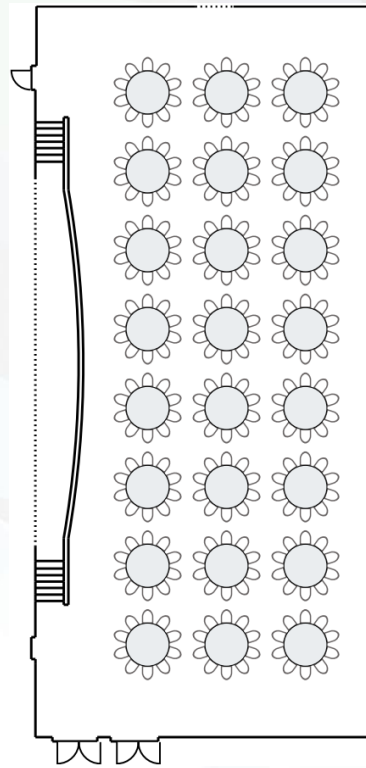
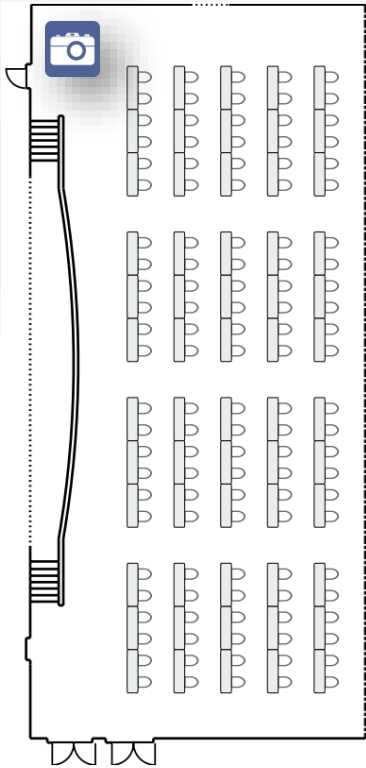

THE MEADOWS

EVENTS & CONFERENCE CENTER

[Index](#) [Event Center Map](#)

Room Name	Square Feet	Dimensions	Ceiling Height	Banquet-Per table 6/8/10	Theater	Classroom Type of table 8/6'	U-Shape	Exhibits 10X10/10X8
Bishop Ballroom B	4,455	45' x 99'	25'	192/256/320	360	132/144	N/A	19

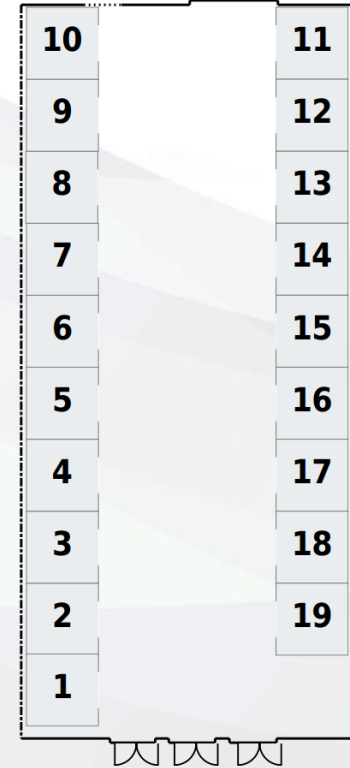
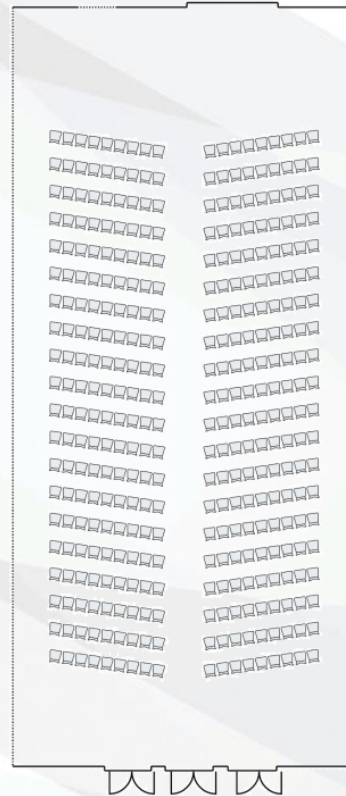
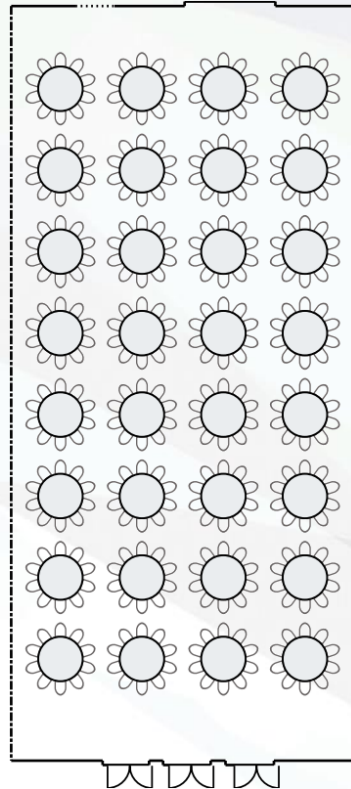
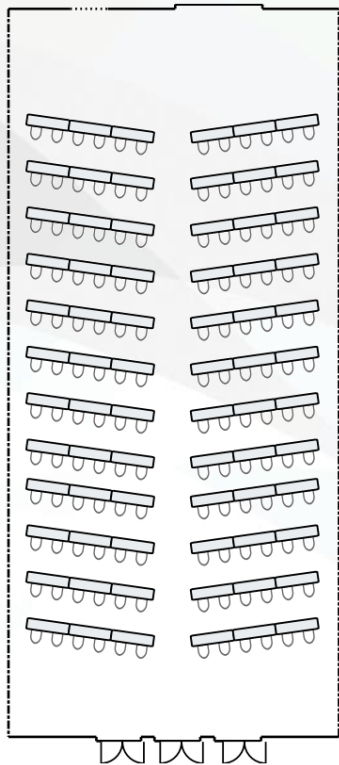

THE MEADOWS

EVENTS & CONFERENCE CENTER

[Index](#)
[Event Center Map](#)

Room Name	Square Feet	Dimensions	Ceiling Height	Banquet-Per table 6/8/10	Theater	Classroom Type of table 8/6'	U-Shape	Exhibits 10X10/10X8
Bishop Ballroom C	3,861	39' x 99'	25'	144/192/240	320	132/104	N/A	17

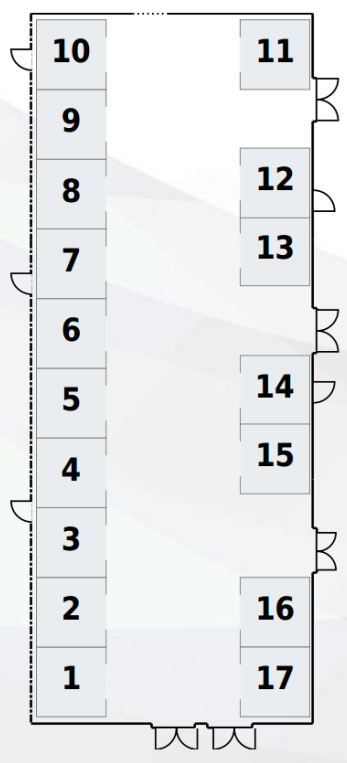
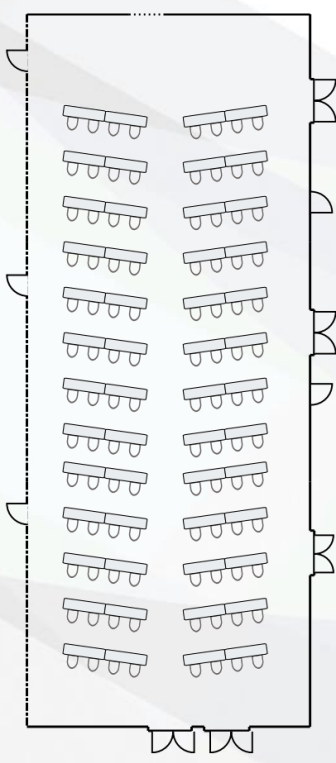
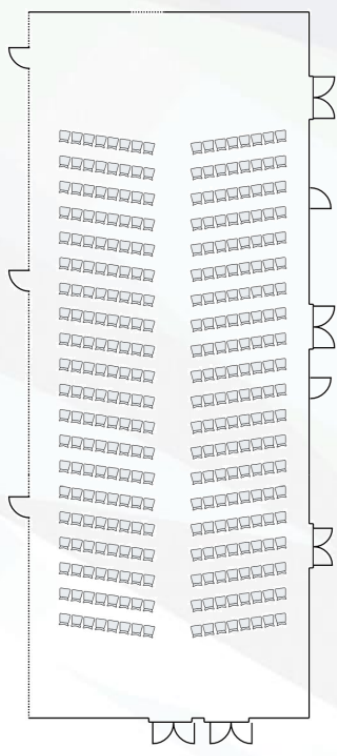
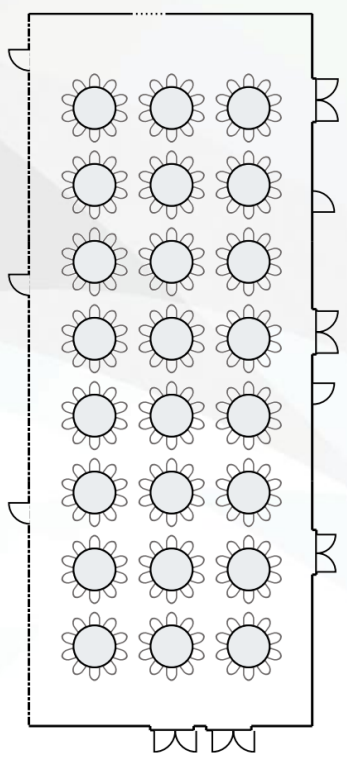

THE MEADOWS

EVENTS & CONFERENCE CENTER

[Index](#)
[Event Center Map](#)

Room Name	Square Feet	Dimensions	Ceiling Height	Banquet-Per table 6/8/10	Theater	Classroom Type of table 8/6'	U-Shape	Exhibits 10X10/10X8
Salon 1	1,326	39' x 34'	25'	54/72/90	112	36/40	36	6

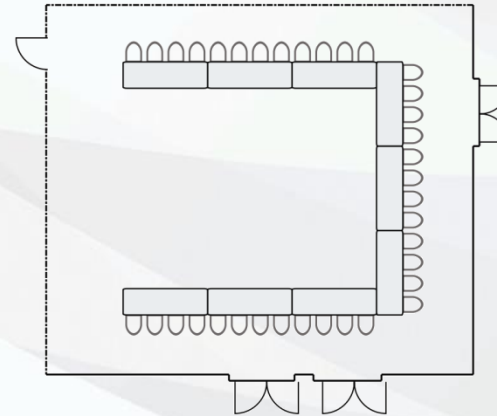
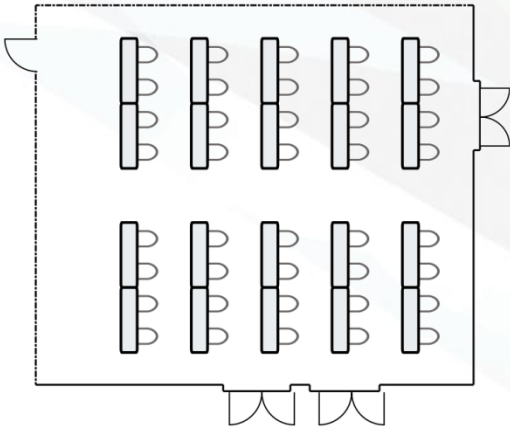
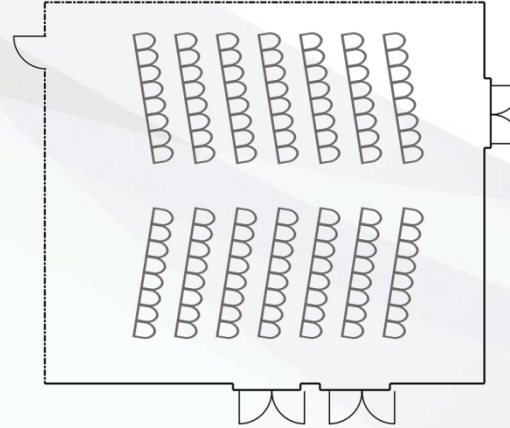
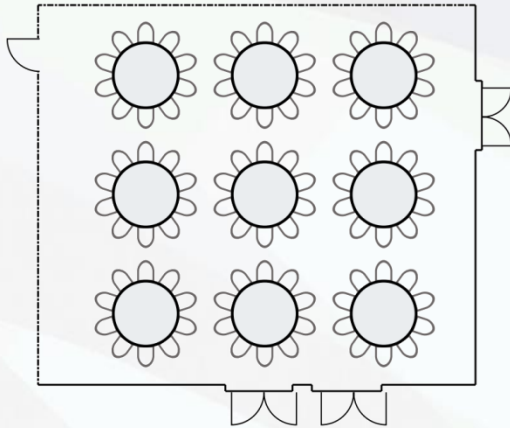

THE MEADOWS

EVENTS & CONFERENCE CENTER

[Index](#)
[Event Center Map](#)

Room Name	Square Feet	Dimensions	Ceiling Height	Banquet-Per table 6/8/10	Theater	Classroom Type of table 8'/6'	U-Shape	Exhibits 10X10/10X8
Salon 2	1,326	39' x 34'	25'	54/72/90	112	36/40	36	6

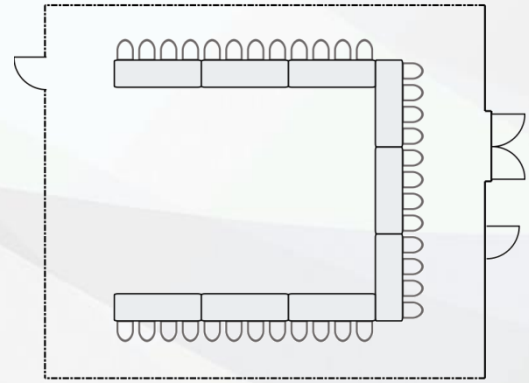
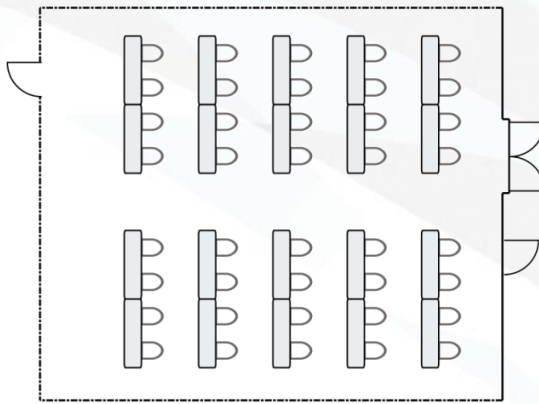
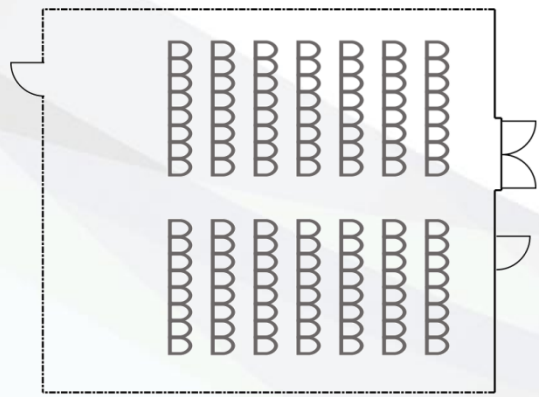
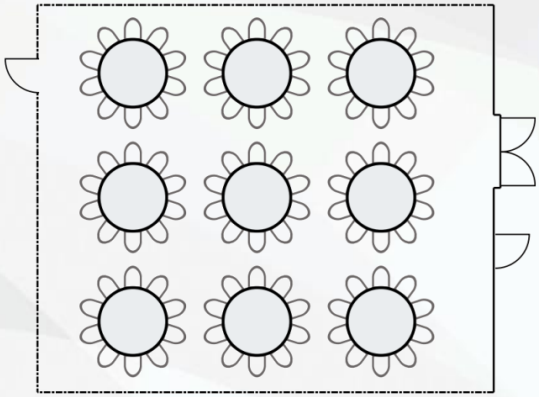

THE MEADOWS

EVENTS & CONFERENCE CENTER

[Index](#)
[Event Center Map](#)

Room Name	Square Feet	Dimensions	Ceiling Height	Banquet-Per table 6/8/10	Theater	Classroom Type of table 8'/6'	U-Shape	Exhibits 10X10/10X8
Salon 3	1,326	39' x 34'	25'	54/72/90	120	36/40	24	6

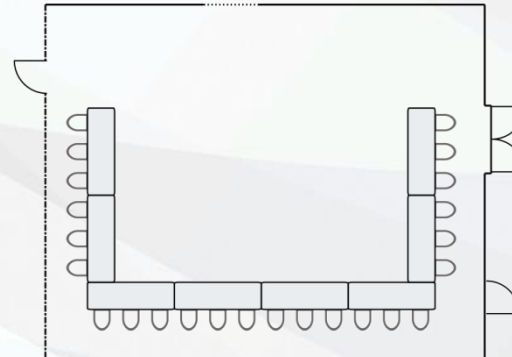
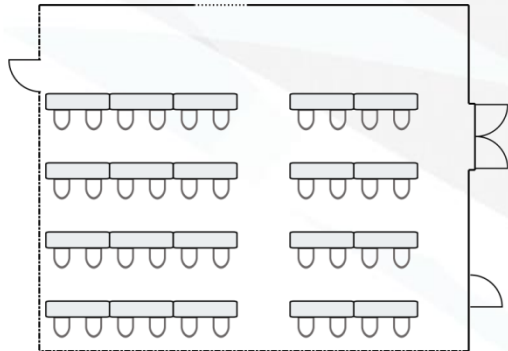
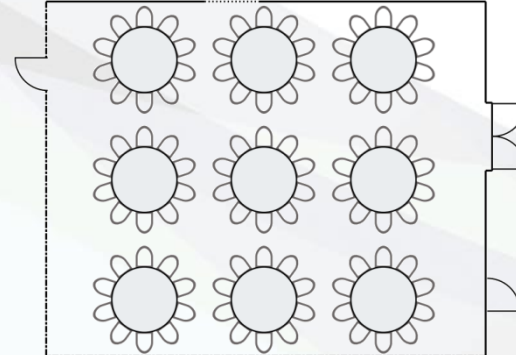
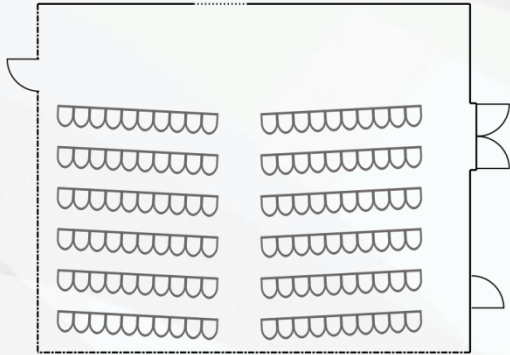

THE MEADOWS

EVENTS & CONFERENCE CENTER

[Index](#)
[Event Center Map](#)

Room Name	Square Feet	Dimensions	Ceiling Height	Banquet-Per table 6/8/10	Theater	Classroom Type of table 8'/6'	U-Shape	Exhibits 10X10/10X8
Polk County Room	720	30' x 24'	9'	24/32/40	72	18/30	18	N/A

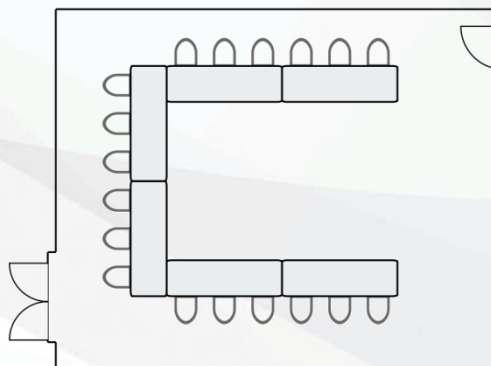
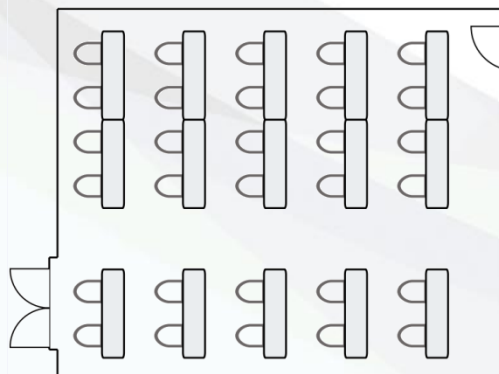
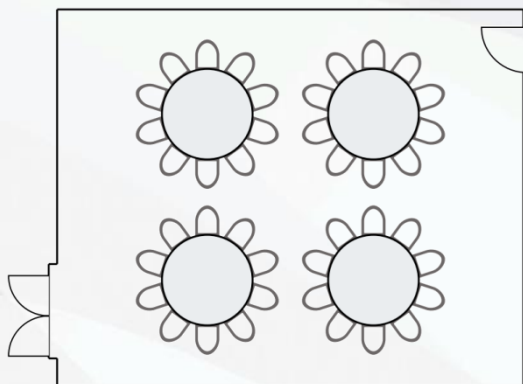

THE MEADOWS

EVENTS & CONFERENCE CENTER

Index Event Center Map

Room Name	Square Feet	Dimensions	Ceiling Height	Banquet-Per table 6/8/10	Theater	Classroom Type of table 8'/6'	U-Shape	Exhibits 10X10/10X8
Skinner Ballroom	6,270	114' x 55'	13'	234/312/390	504	156/180	72	30/30

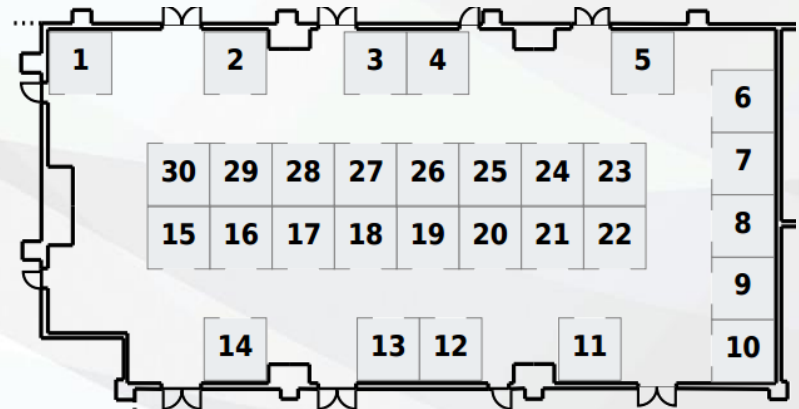
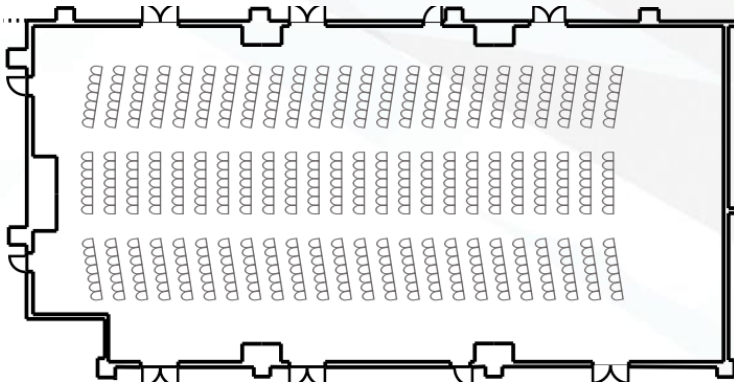
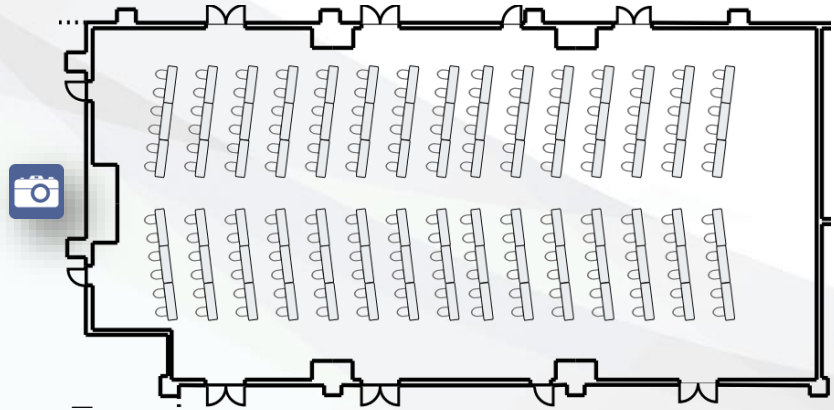
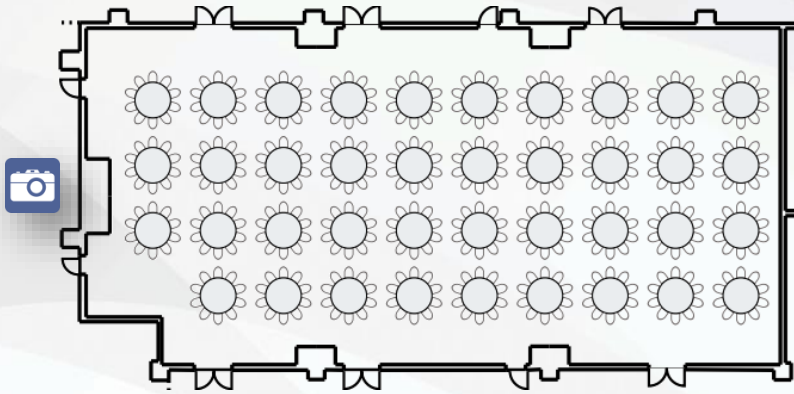

THE MEADOWS

EVENTS & CONFERENCE CENTER

[Index](#)
[Event Center Map](#)

Room Name	Square Feet	Dimensions	Ceiling Height	Banquet-Per table 6/8/10	Theater	Classroom Type of table 8'/6'	U-Shape	Exhibits 10X10/10X8
Skinner Ballroom A	2,090	38' x 55'	13'	72/96/120	192	72/60	33	10/10

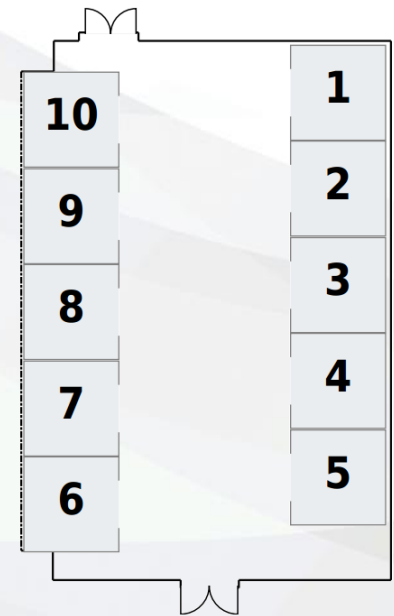
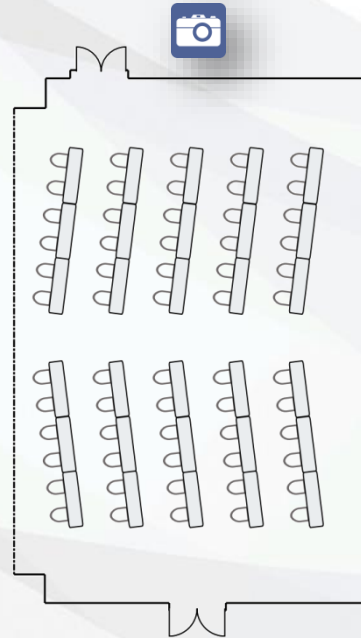
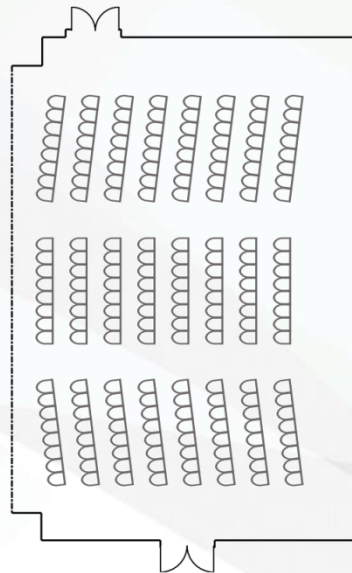
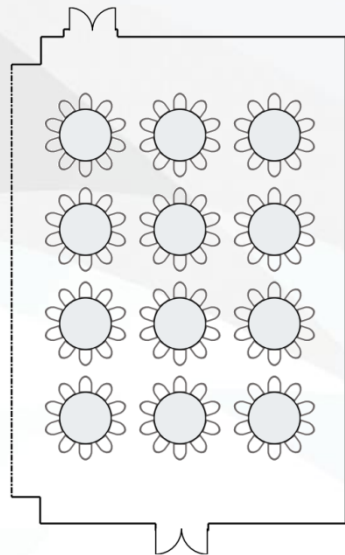

THE MEADOWS

EVENTS & CONFERENCE CENTER

[Index](#)
[Event Center Map](#)

Room Name	Square Feet	Dimensions	Ceiling Height	Banquet-Per table 6/8/10	Theater	Classroom Type of table 8/6'	U-Shape	Exhibits 10X10/10X8
Skinner Ballroom B	2,090	38' x 55'	13'	72/96/120	198	72/70	42	10/10

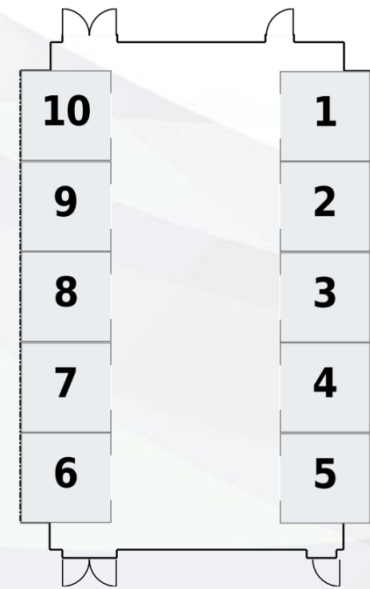
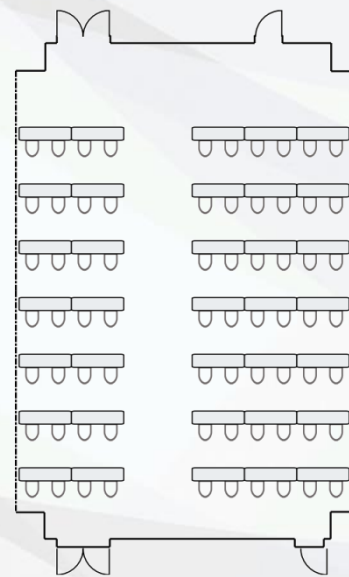
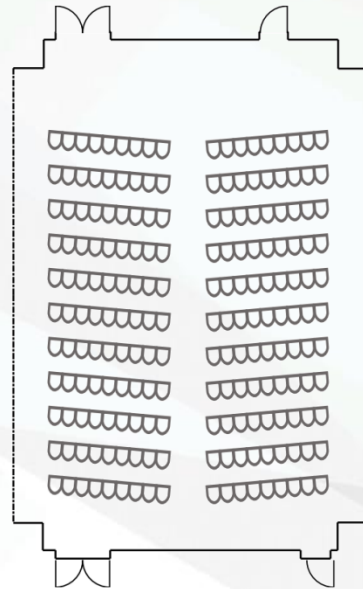
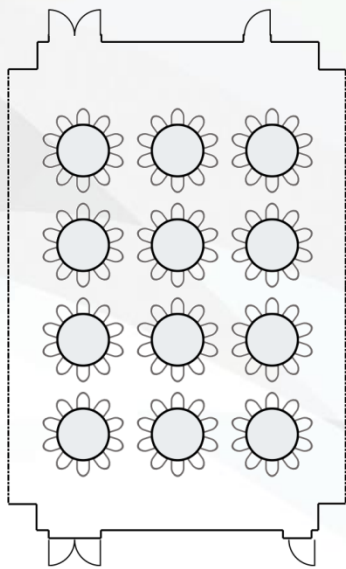

THE MEADOWS

EVENTS & CONFERENCE CENTER

[Index](#)
[Event Center Map](#)

Room Name	Square Feet	Dimensions	Ceiling Height	Banquet-Per table 6/8/10/11	Theater	Classroom Type of table 8'/6'	U-Shape	Exhibits 10X10/10X8
Skinner Ballroom C	1,824	38' x 48'	13'	66/88/110	189	45/52	33	9

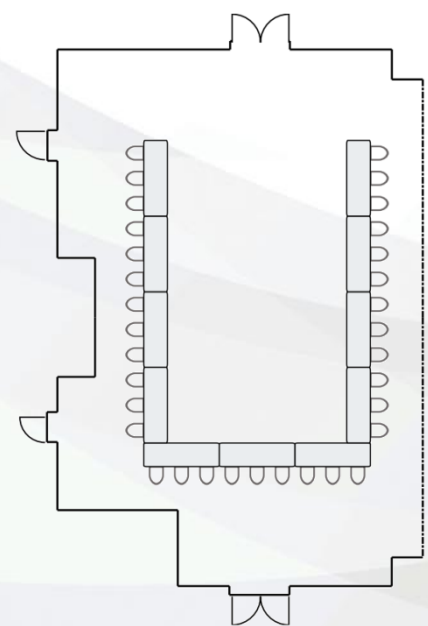
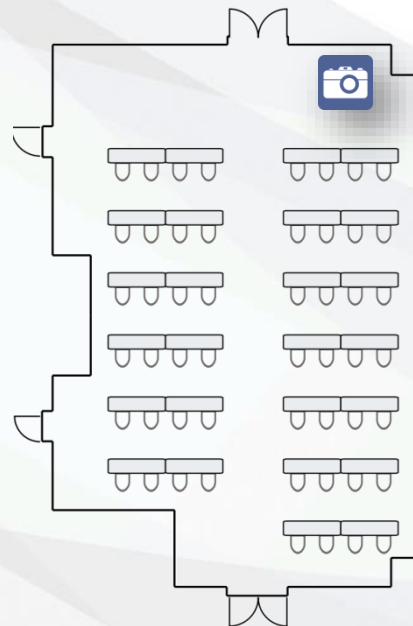
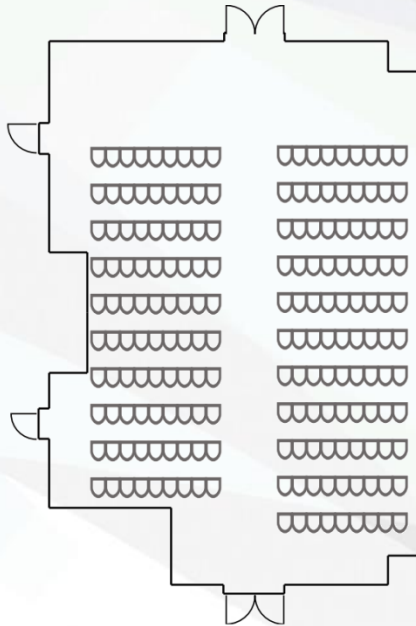
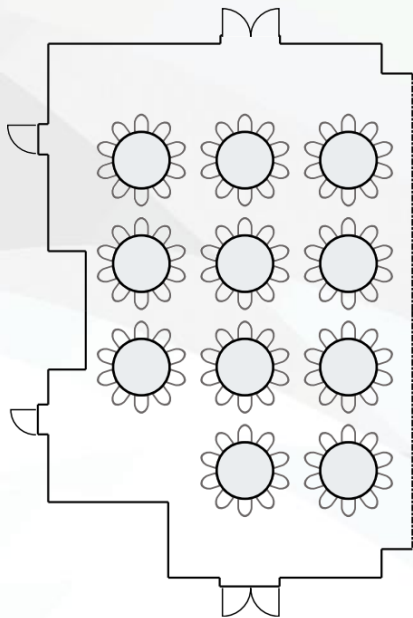

THE MEADOWS

EVENTS & CONFERENCE CENTER

[Index](#)
[Event Center Map](#)

Room Name	Square Feet	Dimensions	Ceiling Height	Banquet-Per table 6/8/10	Theater	Classroom Type of table 8/6'	U-Shape	Exhibits 10X10/10X8
Grandquist Conference Room	780	26' x 30'	10'	24/32/40	60	24	18	N/A

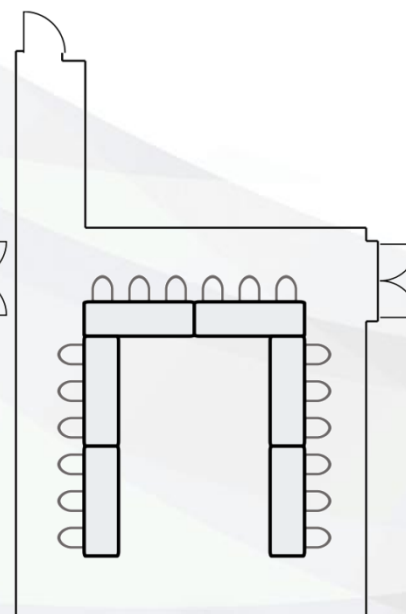
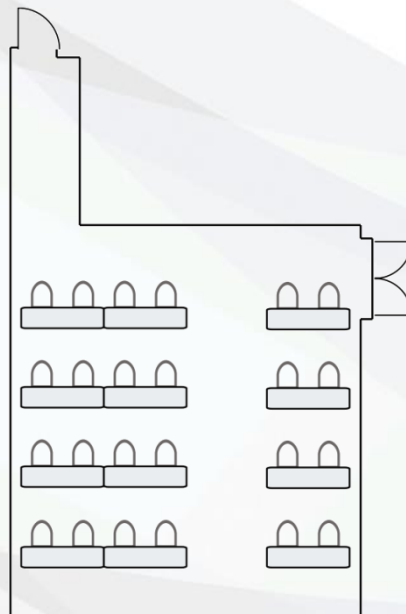
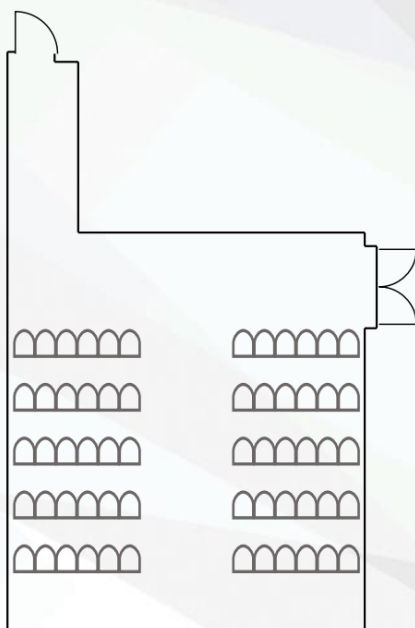
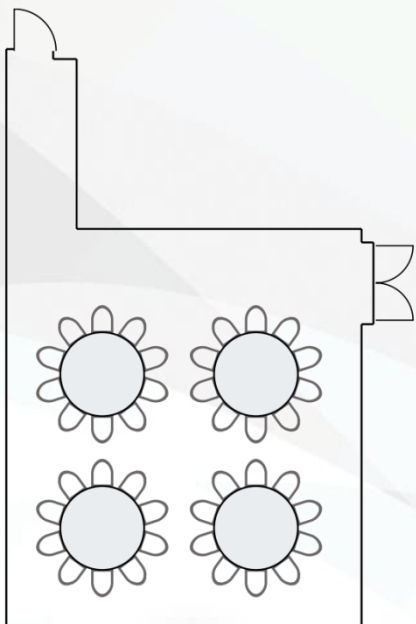

THE MEADOWS

EVENTS & CONFERENCE CENTER

[Index](#)
[Event Center Map](#)

Room Name	Square Feet	Dimensions	Ceiling Height	Banquet-Per table 6/8/10/11	Theater	Classroom Type of table 8/6'	U-Shape	Exhibits 10X10/10X8
Altoona Room	630	30' x 21'	9'	24/32/40	60	18/24	18	N/A

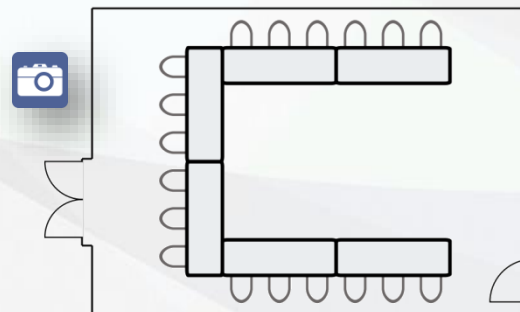
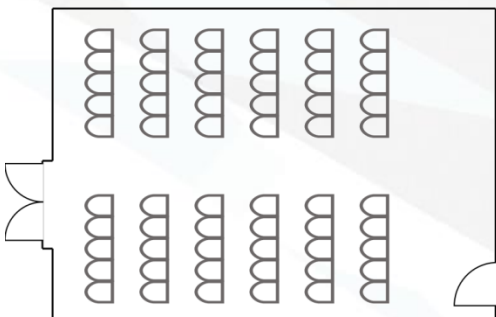
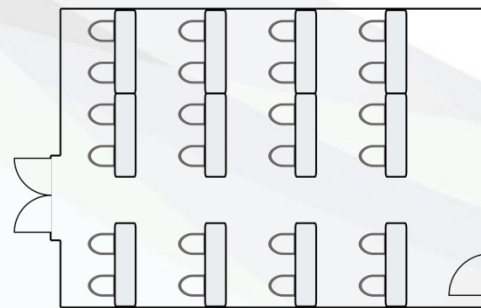
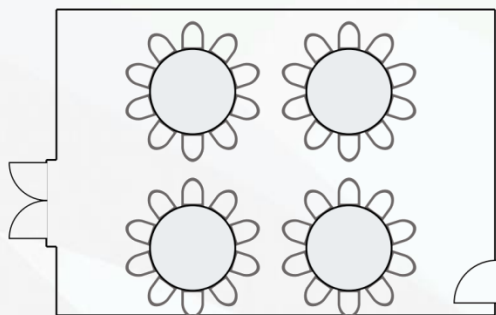

THE MEADOWS

EVENTS & CONFERENCE CENTER

[Index](#)
[Event Center Map](#)

Room Name	Square Feet	Dimensions	Ceiling Height	Banquet-Per table 6/8/10	Theater	Classroom Type of table 8/6'	U-Shape	Exhibits 10X10/10X8
Skinner B1	1,026	38' x 27'	13'	36/48/60	100	36/40	21	N/A

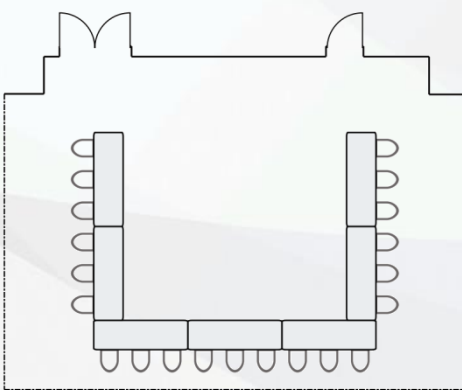
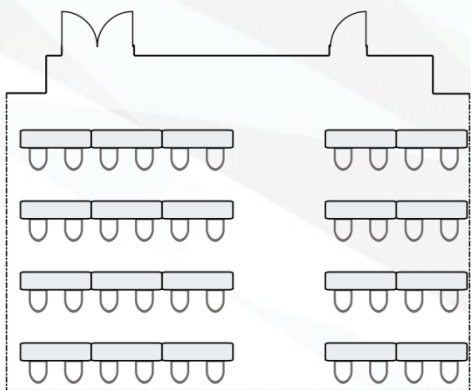
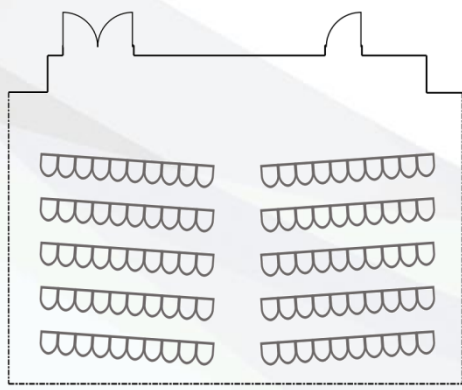
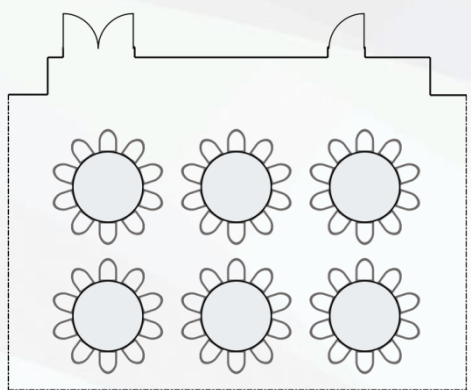

THE MEADOWS

EVENTS & CONFERENCE CENTER

[Index](#)
[Event Center Map](#)

Room Name	Square Feet	Dimensions	Ceiling Height	Banquet-Per table 6/8/10	Theater	Classroom Type of table 8/6'	U-Shape	Exhibits 10X10/10X8
Skinner B2	1,026	38' x 27'	13'	36/48/60	100	36/40	21	N/A

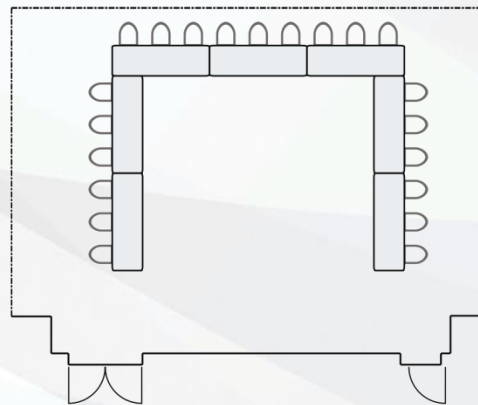
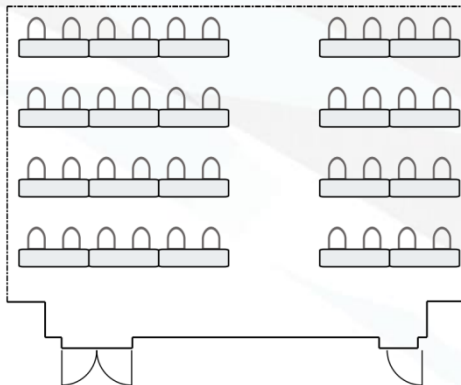
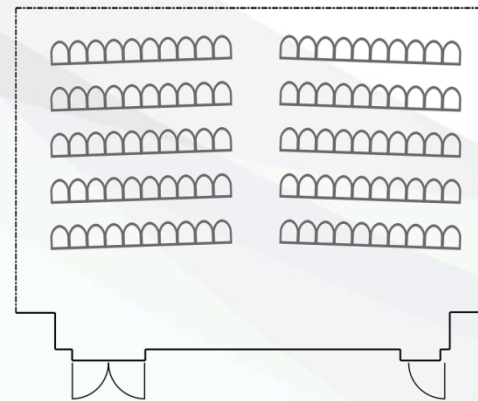
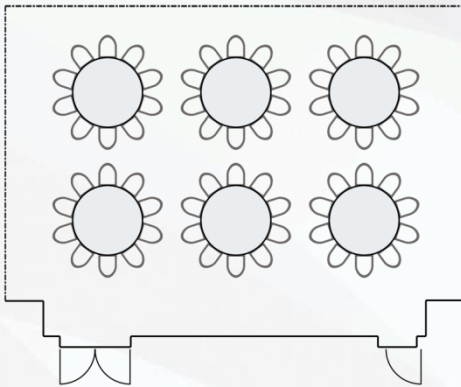

THE MEADOWS

EVENTS & CONFERENCE CENTER

[Index](#) [Event Center Map](#)

Room Name	Square Feet	Dimensions	Ceiling Height	Banquet-Per table 6/8/10	Theater	Classroom Type of table 8/6'	U-Shape	Exhibits 10X10/10X8
Skinner C1	1,026	38' x 27'	13'	30/40/50	94	33/38	21	N/A

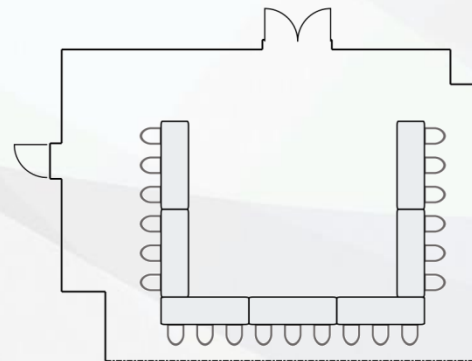
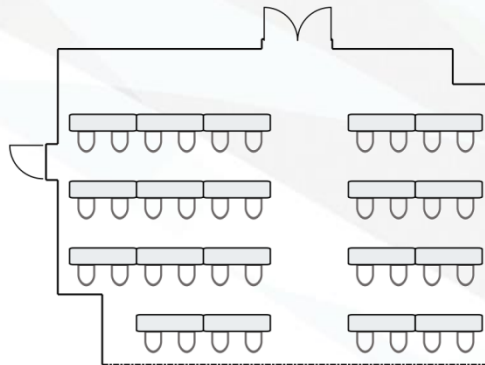
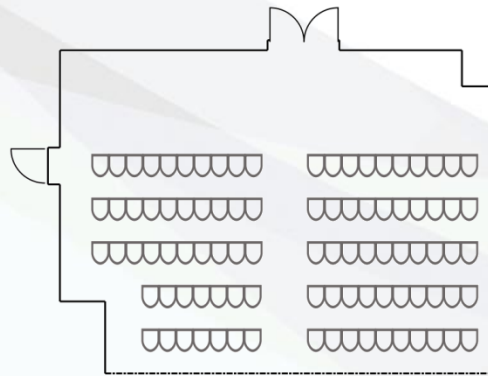
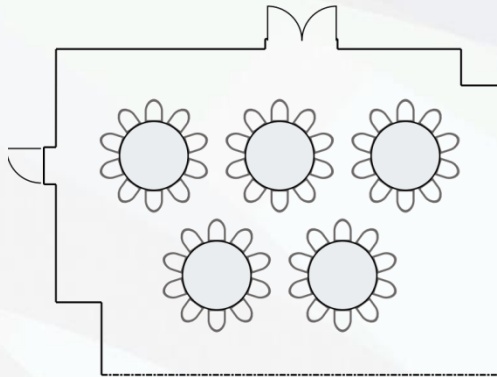

THE MEADOWS

EVENTS & CONFERENCE CENTER

[Index](#)
[Event Center Map](#)

Room Name	Square Feet	Dimensions	Ceiling Height	Banquet-Per table 6/8/10	Theater	Classroom Type of table 8/6'	U-Shape	Exhibits 10X10/10X8
Skinner C2	760	38' x 20'	13'	30/40/50	70	27/28	18	N/A

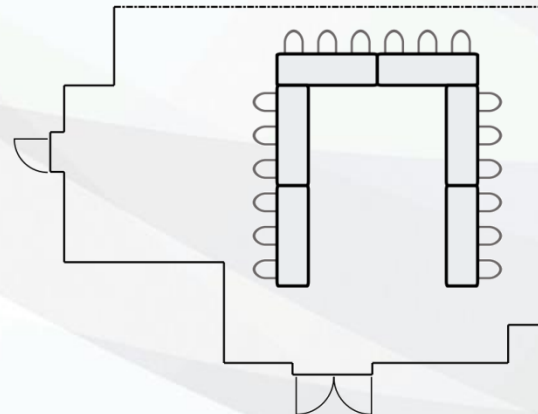
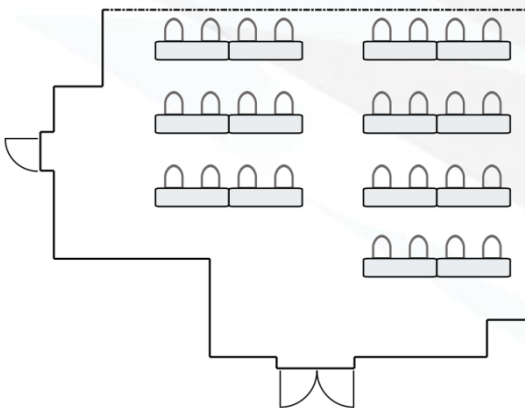
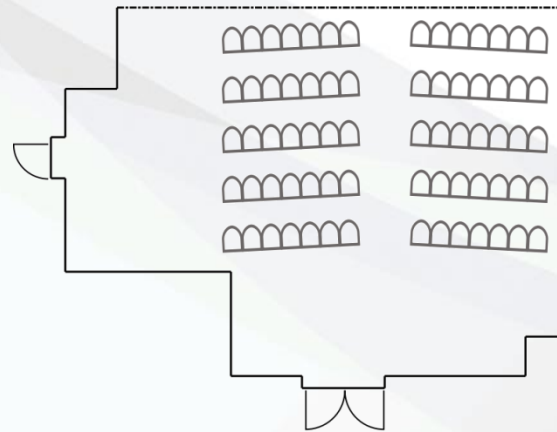
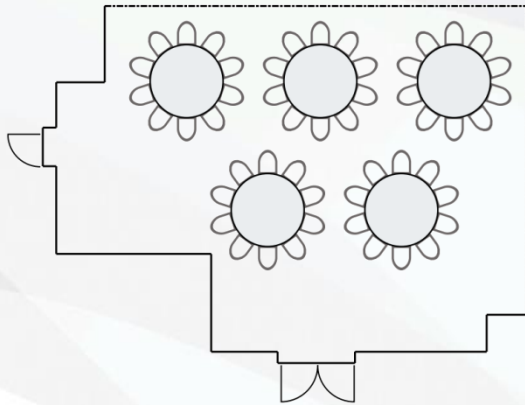

THE MEADOWS

EVENTS & CONFERENCE CENTER

[Index](#)
[Event Center Map](#)

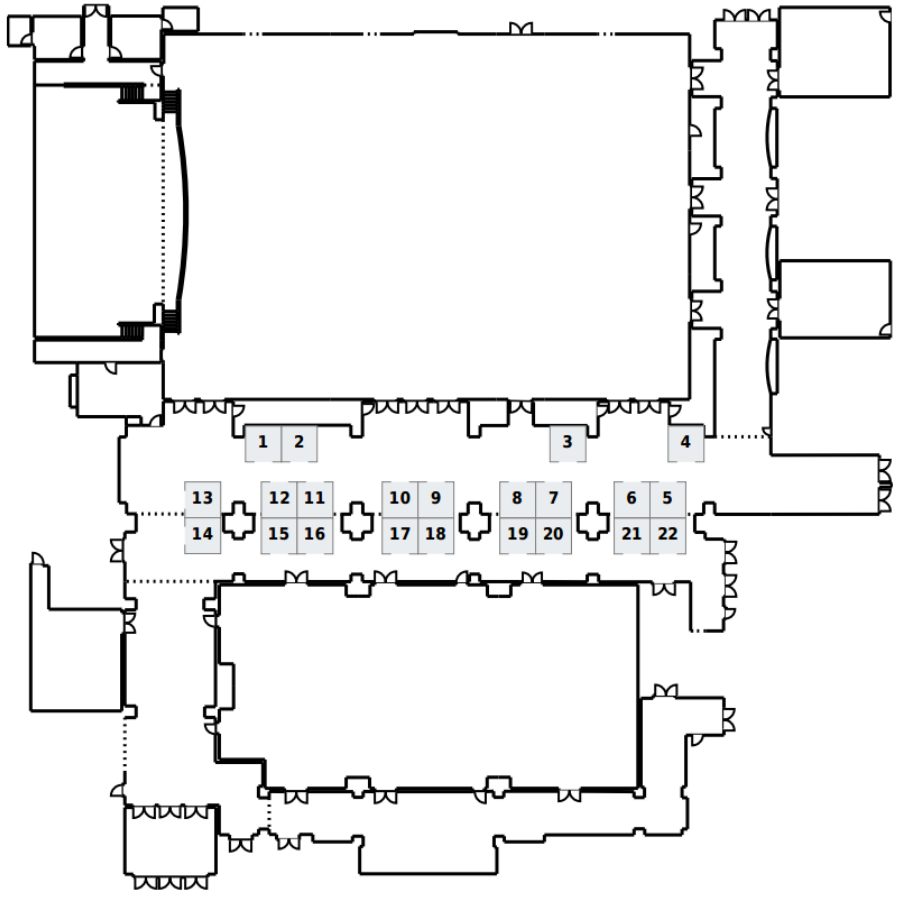

22, 10X8 & 10 X 10 Exhibit booths

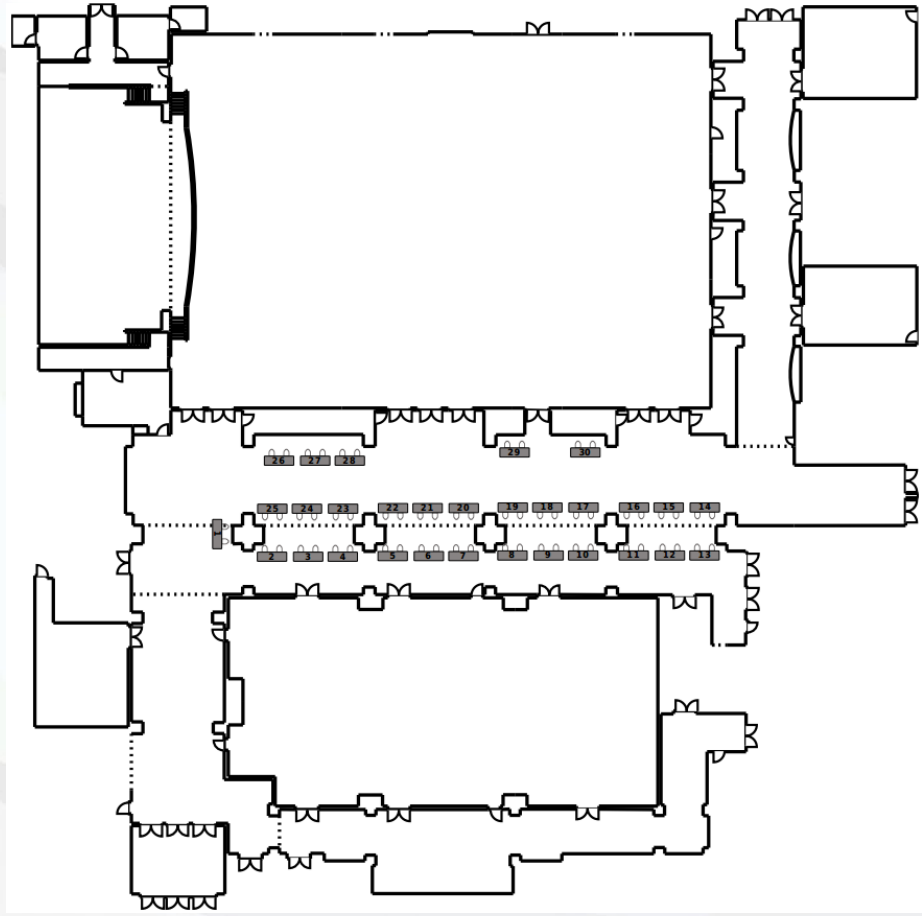

30, 8ft table top displays

THE MEADOWS

EVENTS & CONFERENCE CENTER

[Index](#)
[Event Center Map](#)

Photography



THE MEADOWS

EVENTS & CONFERENCE CENTER

[Index](#)

[Event Center Map](#)

[Photography](#)



THE MEADOWS

EVENTS & CONFERENCE CENTER

[Index](#)

[Event Center Map](#)

Photography



THE MEADOWS

EVENTS & CONFERENCE CENTER

[Index](#)
[Event Center Map](#)

[Photography](#)



THE MEADOWS

EVENTS & CONFERENCE CENTER

[Index](#)
[Event Center Map](#)

[Photography](#)



THE MEADOWS

EVENTS & CONFERENCE CENTER

[Index](#)
[Event Center Map](#)

Photography



THE MEADOWS

EVENTS & CONFERENCE CENTER

[Index](#)
[Event Center Map](#)

Photography



THE MEADOWS

EVENTS & CONFERENCE CENTER

[Index](#)

[Event Center Map](#)

[Photography](#)



THE MEADOWS

EVENTS & CONFERENCE CENTER

[Index](#)
[Event Center Map](#)

[Photography](#)



THE MEADOWS

EVENTS & CONFERENCE CENTER

[Index](#)

[Event Center Map](#)

[Photography](#)



THE MEADOWS

EVENTS & CONFERENCE CENTER

[Index](#)

[Event Center Map](#)

Photography



THE MEADOWS

EVENTS & CONFERENCE CENTER

[Index](#)

[Event Center Map](#)

[Photography](#)



THE MEADOWS

EVENTS & CONFERENCE CENTER

[Index](#)

[Event Center Map](#)

Photography



THE MEADOWS

EVENTS & CONFERENCE CENTER

[Index](#)

[Event Center Map](#)

[Photography](#)

THE MEADOWS

EVENTS & CONFERENCE CENTER

[Index](#)

[Event Center Map](#)

Photography



THE MEADOWS

EVENTS & CONFERENCE CENTER

[Index](#)
[Event Center Map](#)

[Photography](#)



THE MEADOWS

EVENTS & CONFERENCE CENTER

[Index](#)
[Event Center Map](#)

[Photography](#)



THE MEADOWS

EVENTS & CONFERENCE CENTER

[Index](#)
[Event Center Map](#)

Photography

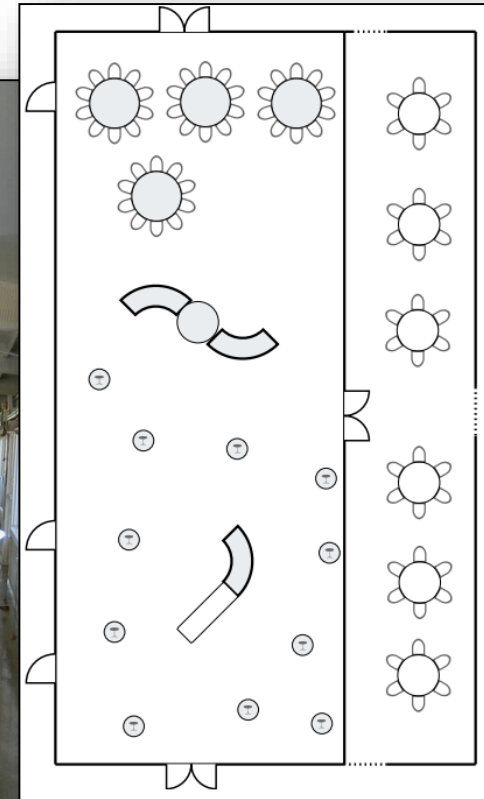

THE MEADOWS

EVENTS & CONFERENCE CENTER

[Index](#)

[Event Center Map](#)

[Photography](#)

